



HFK08

Max Flow: 300 gpm (1135 lpm)



HFK08 In-Line/Tank Mount Filters

Working Pressures to: 350 *psi*
2413 kPa
24.1 bar

Rated Static Burst to: 500 *psi*
3448 kPa
34.5 bar

Flow Range To: 300 *gpm*
1135 *lpm*

Features

HFK08 is available in two styles: in-line and in-tank. Both styles feature a cast aluminum head and steel body for maximum strength and durability. Its single, center retention bolt simplifies servicing. Flow is from inside to outside of the filter cartridge.

Three in-stock HFK08 models offer our proprietary Synteq™ synthetic media designed especially for liquid filtration. A wider range of filter media is available to purchase separately, as are fluor elastomer seals. A visual service indicator is built into the HFK08 head.



In-line model shown

Beta Rating

- Performance to $\beta_{<4(c)}=1000$

Porting Size Options

- 3" NPT
- SAE-20 O-ring

Assembly Weight

- 55.4 lbs / 25.12 kg

Replacement Filter Length

- 18" / 457mm

Standard Bypass Ratings

- 25 *psi* / 172.5 kPa / 1.7 bar

Operating Temperatures

- -20°F to 250°F
-29°C to 121°C

Filter Burst Ratings

- 75 *psi* / 517 kPa / 5.2 bar (synthetic)
- 100 *psi* / 689 kPa / 6.9 bar (wire mesh)

HFK08 Specification Illustrations

All dimensions are shown in inches [millimeters].

Assembly - Side Views

In-Line Model

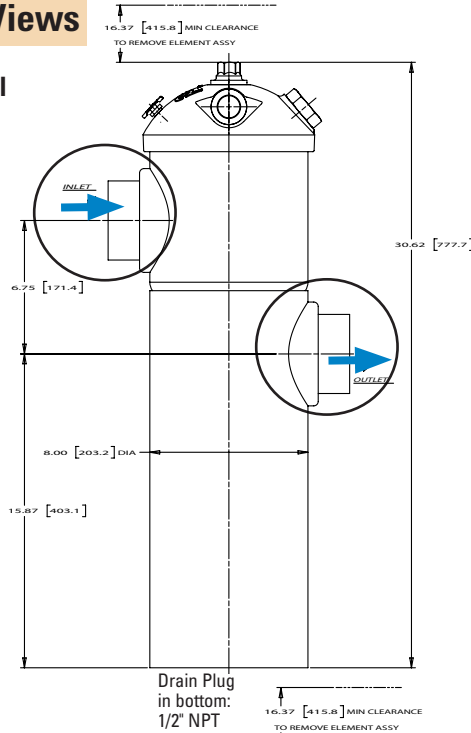

In-Tank Model

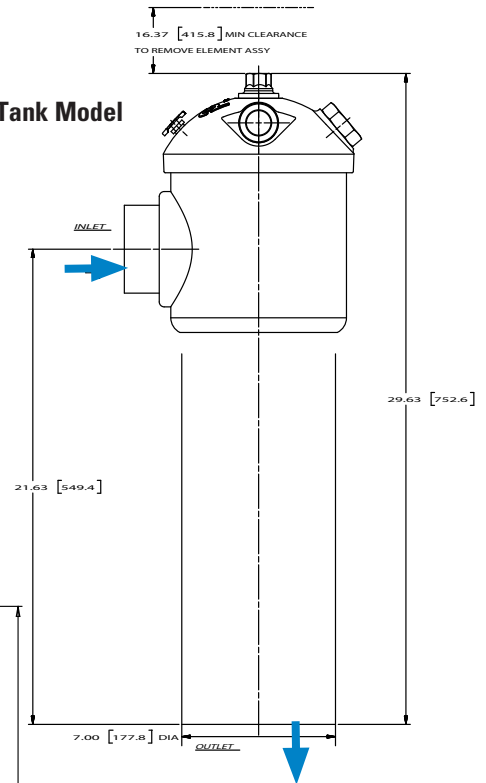

K080087 In-Line Model

Smaller port size (SAE-20) works well for kidney loop filtration.

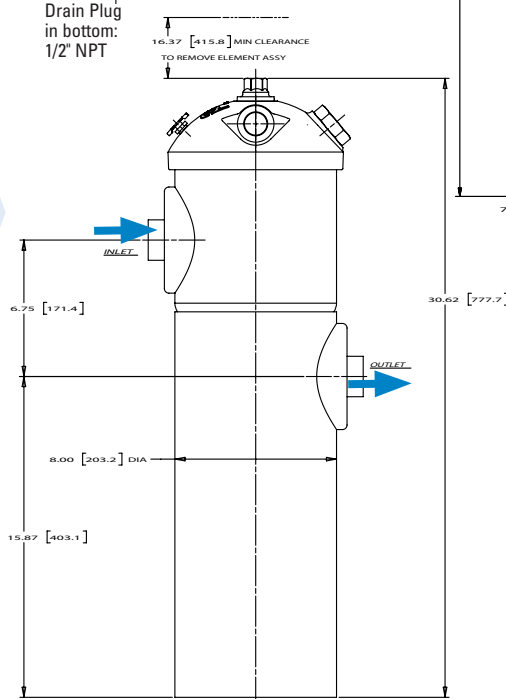

Head - Top View

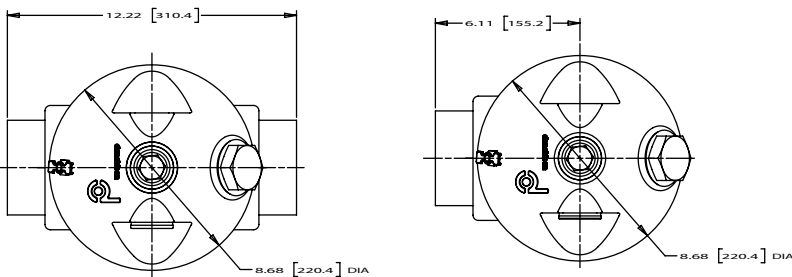

Applications

- Fluid Conditioning Systems
- Lube Oil Systems
- Return Lines
- Side Loop Systems
- Suction Lines



HFK08
Max Flow: 300 gpm (1135 lpm)



HFK08 Components Filter Assemblies

Port Size	Bypass Rating	Indicator Style ¹ & Location	Assembly Part No.	Length (in./mm)	Filter Part No.
3" NPT	25 psi / 172.5 kPa	Visual, Left side	K080051, In-Tank	18"/457mm	P164703
		Visual, Right side	K080033, In-Line	18"/457mm	P164703
			K080085, In-Line	18"/457mm	P164407 Viton® Seal
SAE-20	25 psi / 172.5 kPa	Visual, Right side	K080087, In-Line	18"/457mm	P164405

Assembly Notes

¹ Donaldson uses the inlet port as the reference point. "Left side," for instance, means that the indicator mounts on the side of the filter head that is on your left when you face the inlet port. Viton® is a registered trademarks of E. I. DuPont de Nemours and Company.

Filter Choices

Media Type	$\beta_{x(c)} = 2$ Rating based on ISO 16889	$\beta_{x(c)} = 1000$	Length in mm	Donaldson Part No.
Synteq Synthetic	<4 μ m	18	457.2	P164407 Viton® seal
	<4 μ m	18	457.2	P164405
	7 μ m	18	457.2	P166462
	9 μ m	18	457.2	P176222
	23 μ m	18	457.2	P164703
Wire Mesh	45 μ m	18	457.2	P173573
	150 μ m	18	457.2	P163945

Filter Notes

- Standard HDK06 replacement filters have Buna-N® seals, which are appropriate for most applications involving petroleum oil. Filters with seals made of fluorocarbon elastomer (such as Viton® and Fluorel®) are required when using diester, phosphate ester fluids, water glycol, water/oil emulsions, and HWCFC (high water content fluids) over 150°F.
- HDK06 filters are inside to outside reverse flow 4.39" (112mm) OD.
- Refer to the table in the Technical Reference Guide for fluid compatibility with our filter media.

Viton® is a registered trademarks of E. I. DuPont de Nemours and Company.
Fluorel® is a registered trademark of 3M Company.



The K080087 model has features that are perfect for kidney loop filtration.

Performance Data

HFK08 Filter Only

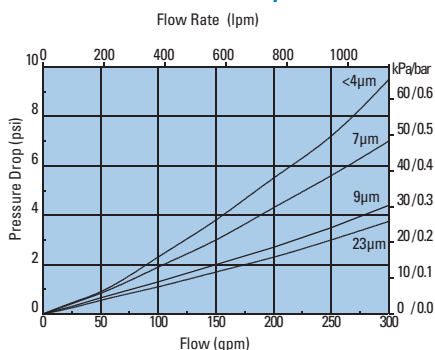

HFK08 Housing Only

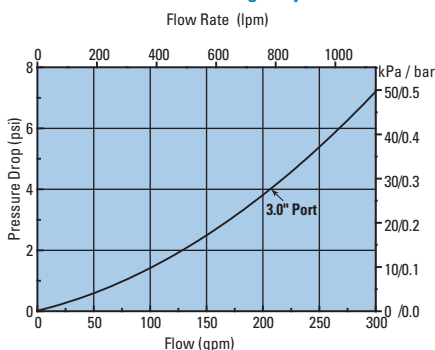

K080087 Assembly (with Filter)

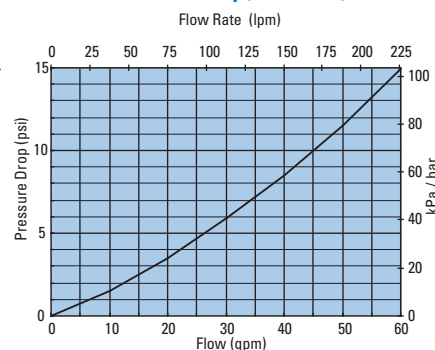

HFK08 Service Parts

SERVICE PARTS NOTE:

Some service parts may not be stocked. Please contact your Donaldson sales representative for lead time details.

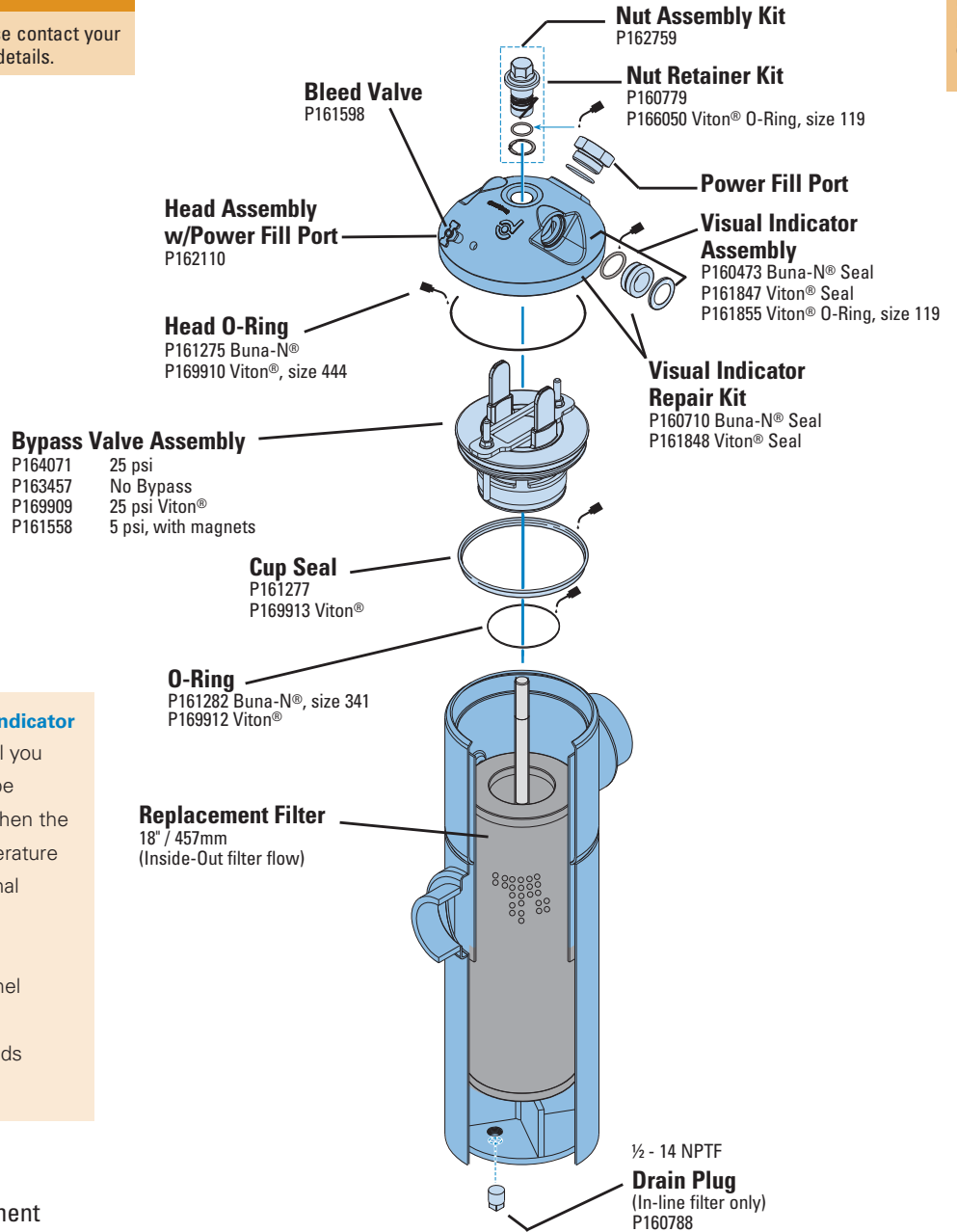

How to Read the Visual Indicator

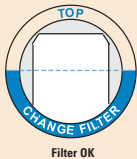

This simple device will tell you when the filter needs to be changed. Always check when the fluid is at operating temperature and the system is at normal operating flow.

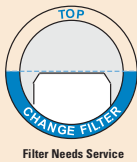

If the top of the white panel is below the lower half of the window, the filter needs servicing.

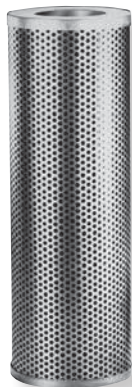

HFK08 replacement filters are available with synthetic or wire mesh media.

