

# OMIT



Filtri sfiati aria  
Air filters

# TSA

## Filtro sfiato aria

### Air filter



i filtri sfiato aria si montano sui serbatoi per filtrare l'aria che entra a compensazione della variazione di volume del fluido. Si montano inoltre sull'aspirazione di compressori e motori a scoppio.

Disponibili con attacchi filettati Gas.

Gli elementi filtranti sono rigenerabili in rete vellutata, con grado di filtrazione standard 40 Micron.

Air filters are mounted on oiltanks with the aim to filter the air.

They are also mounted in suction of compressors and engines.

Available with BSP threads.

Replace elements are regenerated in velvet net in 40 Micron.

## Esempio codice di ordinazione - Ordering example

# TSA 33 - 14

Serie  
Series

Tipo / Type
33
50
70
107
135
166

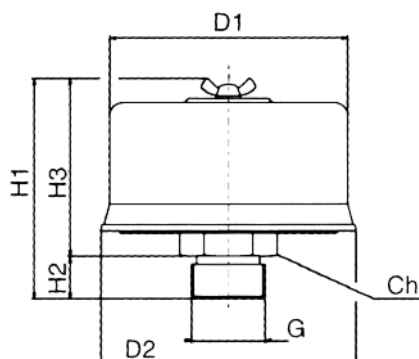

### ATTACCHI / CONNECTIONS

Codice Code	Portata /min	D1	D2	H1	H2	H3	G	Ch
<b>TSA33-14</b>	140	33	36	48	13	35	1/4"	22
<b>TSA33-38</b>	140	33	36	48	13	35	3/8"	22
<b>TSA33-12</b>	140	33	36	48	13	35	1/2"	22
<b>TSA50-14</b>	200	50	53	63	13	50	1/4"	22
<b>TSA50-38</b>	500	50	53	63	13	50	3/8"	22
<b>TSA70-12</b>	500	70	76	80	13	67	1/2"	27
<b>TSA70-34</b>	500	70	76	80	17	63	3/4"	32
<b>TSA107-100</b>	800	107	114	99	19	80	1"	38
<b>TSA135-112</b>	1500	135	143	132	25	107	1 1/2"	55
<b>TSA166-212</b>	2000	166	175	172	25	147	2 1/2"	80

# CSA

## Filtro sfiato aria Air filter



i filtri sfiati aria serie CSA si montano sui serbatoi per filtrare l'aria che entra a compensazione della variazione di volume del fluido.

Sono costituiti da una cartuccia SPIN-ON da avvitare ad un supporto da saldare o flangiare al serbatoio.

Air filters are mounted on oiltanks with the aim to filter the air.

They are formed by a SPIN-ON replace element to screw to a support to be welded or to be flanged to the oil tank.

### Esempio codice di ordinazione - Ordering example

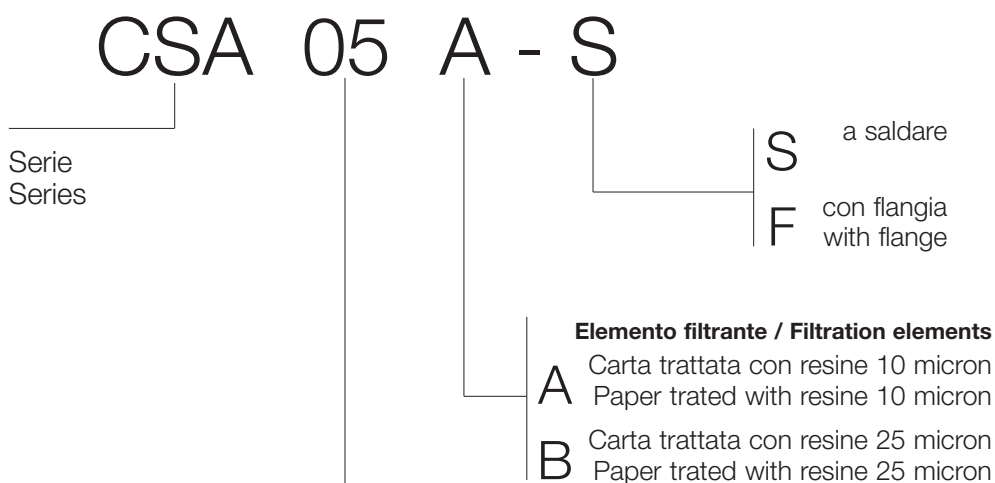

Dimensioni cartuccia / Dimensions			
Codice Code	D1	D2	H1
05	3/4" BSP	98	145
06	3/4" BSP	98	165
10	1 1/4" BSP	132	180
15	1 1/4" BSP	132	205

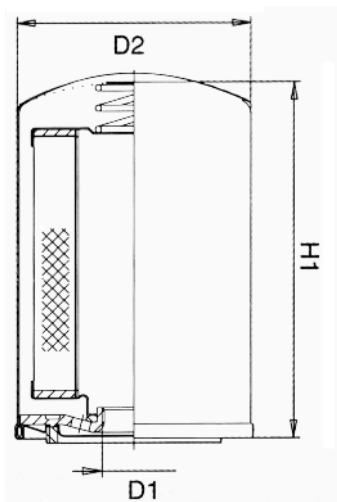

per / for  
**CSA05 - 06**

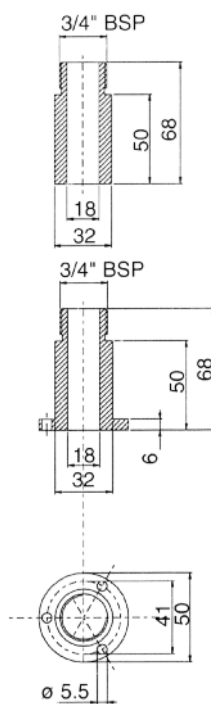

per / for  
**CSA10 - 15**

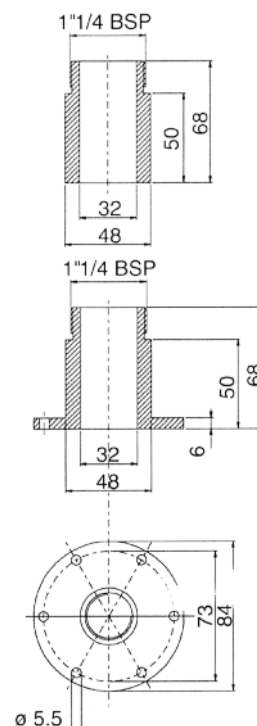

SCAMBIATORI  
HEAT EXCHANGERS

FILTRI  
FILTERS

ACCESSORI  
ACCESSORIES

COMPONENTI  
COMPONENTS

FLANGE / FLANGES  
RACCORDI / COUPLINGS  
BLOCCHI / MANIFOLDS

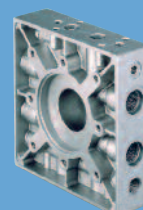
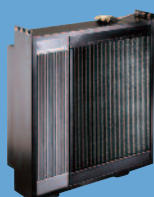
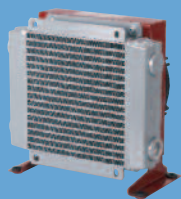

**OMIT**