



Needle Valves

MATERIALS OF CONSTRUCTION	
VALVE BODY:	BRASS
STEM:	BRASS

NEEDLE VALVE NOMENCLATURE	
EXAMPLE: NV101F-4-2	ATTRIBUTE:
NV	NEEDLE VALVE
101	ANGLE NEEDLE VALVE
F	FLARED TO MALE PIPE
4	1/4" TUBE O.D.
2	1/8" PIPE THREAD

SPECIFICATIONS	
PRESSURE RANGE	VALVES UP TO 150 PSI UNLESS OTHERWISE NOTED
TEMPERATURE RANGE	SEE SPECIFIC PART NUMBER FOR TEMPERATURE RANGE



Needle valves have metal-to-metal seats with fine thread screwdown. Brass construction with specially formulated low temperature seal which remains elastic to temperature as low -40°F.

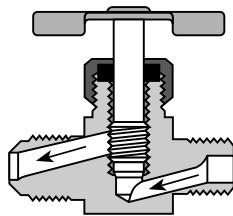

Needle Valves Installation Instructions

Series NV valves should always be installed with the pressure against the seat. Refer to drawing to determine correct direction of flow.



Angle Needle Valve NV101F

Flare to Male Pipe
Temperature Range: -45° to +250° F

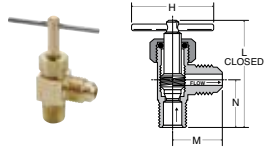

PART NO.	TUBE SIZE	PIPE THREAD	H	L	M	N
NV101F-4-2	1/4	1/8	1.50	1.58	.75	.66
NV101F-6-4	3/8	1/4	1.38	1.86	.95	.90

Needle Valve NV102F

Flare to Flare *Provided with Pin Handle
Temperature Range: -45° to +250° F

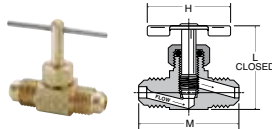

PART NO.	TUBE SIZE	H	L	M
NV102F-4*	1/4	1.50	1.34	1.50
NV102F-6	3/8	1.38	1.55	1.86

Needle Valve NV103F

Flare to Male Pipe *Provided with Pin Handle
Temperature Range: -45° to +250° F

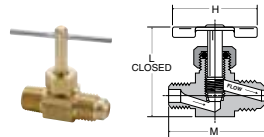

PART NO.	TUBE SIZE	PIPE THREAD	H	L	M
NV103F-4-2*	1/4	1/8	1.50	1.33	1.35
NV103F-6-4	3/8	1/4	1.38	1.56	1.73

Humidifier Valve HV104C

Temperature Range: -45° to +250° F

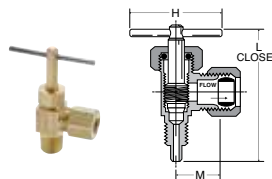

PART NO.	TUBE SIZE	PIPE THREAD	H	L	M
HV104C-4-2	1/4	1/8	1.50	1.89	.53

Humidifier Valve clamp kit HV104C-kit

Temperature Range: -30° to +250° F
Clamp fits 3/8" O.D. through 1.315" O.D. tube or pipe.
Kit includes 60PT-4 and 63PT-4 for assembly with plastic or nylon tubing. For complete kit, specify entire part number as shown below:

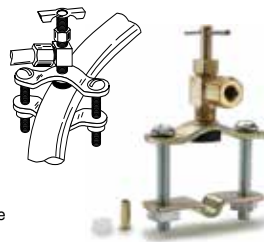

PART NO.	TUBE SIZE	PIPE THREAD
HV104C-4-2 KIT	1/4	1/8

Self-Piercing Humidifier Valve clamp kit SPV104C-kit

Temperature Range: -30° to +250° F
Clamp fits 3/8" O.D. through 1.315" O.D. tube or pipe. Kit includes 60PT-4 and 63PT-4 for assembly with plastic or nylon tubing. For complete kit, specify entire part number as shown below:

Plastic sleeve and brass insert for 1/4" O.D. x .040 wall plastic tubing
Brass sleeve for 1/4" O.D. copper tube

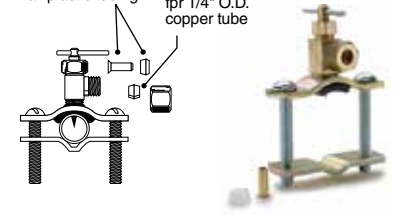

PART NO.	TUBE SIZE	PIPE THREAD
SPV104C KIT	1/4	1/8

Angle Needle Valve NV104C-NV104CA

Compression to Male Pipe *Provided with Pin Handle
Temperature Range: -45° to +250° F

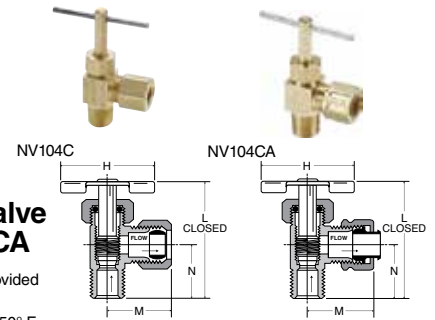

PART NO.	TUBE SIZE	PIPE THREAD	H	L	M	N
NV104C-4-2*	1/4	1/8	1.50	1.54	.88	.67
NV104CA-4-2*	1/4	1/8	1.50	1.49	.77	.66
NV104C-4-4	1/4	1/4	1.38	1.80	.93	.75
NV104C-5-2*	5/16	1/8	1.50	1.63	.88	.68
NV104C-6-4	3/8	1/4	1.38	1.76	.94	.81

Needle Valve NV105C-NV105CA

Compression to Compression
*Provided with Pin Handle
Temperature Range: -45° to +250° F

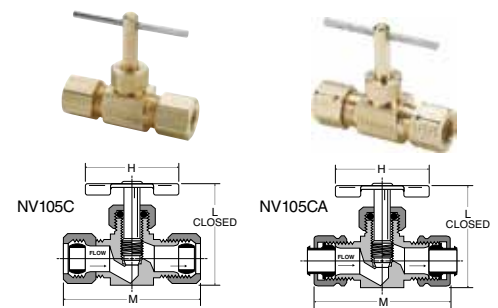

PART NO.	TUBE SIZE	H	L	M
NV105C-4*	1/4	1.50	1.41	1.75
NV105C-5*	5/16	1.50	1.35	1.73
NV105C-6	3/8	1.38	1.55	1.93
NV105CA-4*	1/4	1.50	1.41	1.64
NV105CA-6	3/8	1.38	1.55	1.78



Needle Valve NV106C-NV106CA

Compression to Male Pipe
 *Provided with Pin Handle
 Temperature Range: -45° to +250° F

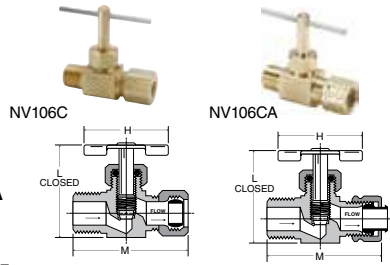

PART NO.	TUBE SIZE	PIPE THREAD	H	L	M
NV106C-4-2*	1/4	1/8	1.50	1.41	1.53
NV106C-4-4*	1/4	1/4	1.50	1.40	1.55
NV106C-5-2*	5/16	1/8	1.50	1.35	1.50
NV106C-6-4	3/8	1/4	1.38	1.56	1.75
NV106CA-4-2	1/4	1/8	1.50	1.41	1.47
NV106CA-4-4*	1/4	1/4	1.50	1.33	1.52
NV106CA-6-4	3/8	1/4	1.38	1.53	1.78

Needle Valve NV107P

Male Pipe to Male Pipe
 *Provided with Pin Handle
 Temperature Range: -45° to +250° F

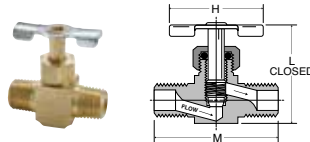

PART NO.	PIPE THREAD	H	L	M
NV107P-2*	1/8	1.50	1.35	1.25
NV107P-4	1/4	1.38	1.54	1.65

Needle Valve NV108P

Female Pipe to Male Pipe
 *Provided with Pin Handle
 Temperature Range: -45° to +250° F

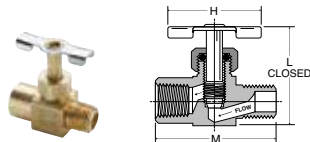

PART NO.	PIPE THREAD	H	L	M
NV108P-2*	1/8	1.50	1.36	1.25
NV108P-4	1/4	1.38	1.56	1.61

Needle Valve NV109P

Female Pipe to Female Pipe
 *Provided with Pin Handle
 Temperature Range: -45° to +250° F

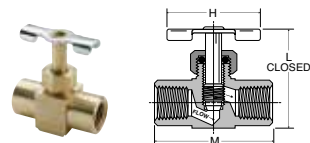

PART NO.	PIPE THREAD	H	L	M
NV109P-2*	1/8	1.50	1.35	1.25
NV109P-4	1/4	1.38	1.53	1.60

Needle Valve NV311P

Poly-Tite to Male Pipe
 Temperature Range: 0° to +150° F

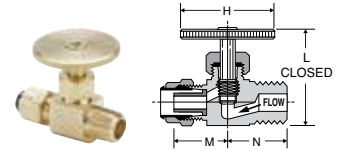

PART NO.	TUBE SIZE	PIPE THREAD	H	L	M	N
NV311P-4-2	1/4	1/8	1.07	1.17	.50	.63
NV311P-4-4	1/4	1/4	1.07	1.18	.50	.72
NV311P-6-4	3/8	1/4	1.07	1.19	.56	.72

Angle Needle Valve NV312P

Poly-Tite to Male Pipe
 Temperature Range: 0° to +150° F

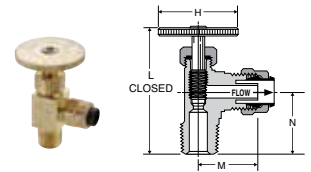

PART NO.	TUBE SIZE	PIPE THREAD	H	L	M	N
NV312P-4-2	1/4	1/8	1.07	1.53	.48	.68
NV312P-4-4	1/4	1/4	1.07	1.72	.56	.86
NV312P-6-4	3/8	1/4	1.07	1.68	.64	.86

