



W322

Max Flow: 50 gpm (190 lpm)



W322 In-Line Cartridge Filters

Working Pressures to: 3000 *psi*
20,700 kPa
207 bar

Rated Static Burst to: 7,500 *psi*
51,700 kPa
517 bar

Fatigue Pressure Rating: 2000 *psi*
13,800 kPa
138 bar

Flow Range to: 50 *gpm*
190 *lpm*



Features

The W322 duplex filter assembly provides continuous, uninterrupted filtering of flows up to 50 gpm. The proprietary housing check valves ensure leak free maintenance during replacement filter cycle. The high density aluminum material provides for a compact and lightweight filter design. Donaldson DT high-performance 4-layer media is offered in five different media grades. The differential pressure indicator line is designed to work with wide assortment of bypass valves. Thermal lockout and surge control are two key features incorporated in many of the differential pressure indicators.

- Anodized aluminum head and housing
- Duplex offers continuous filtration
- Two housing length options

Beta Rating

- Performance to $\beta_{<4(c)}=1000$

Porting Size Options

- SAE-16 O-ring

Assembly Weight

- 6.88": 34 lbs / 15.5 kg
- 9.86": 36 lbs / 16.4 kg

Replacement Filter Lengths

- 4.41" / 111.9mm
- 4.46" / 113.2mm
- 8.16" / 207.2mm
- 8.28" / 210.3mm

Standard Bypass Ratings

- 90 psi / 621 kPa / 6.2 bar
- 50 psi / 345 kPa / 3.5 bar
- No Bypass

Operating Temperatures

- -20° to 250°F (-29° to 121°C)

Filter Collapse Ratings

- 150 psi / 1034 kPa / 10.3 bar (standard)
- 3000 psi / 20,700 kPa / 206.8 bar (high collapse)

W322 Specification Illustrations

All dimensions are shown in millimeters [inches].

Indicator Switch Schematic Wiring Diagram Aluminum Electrical Housings

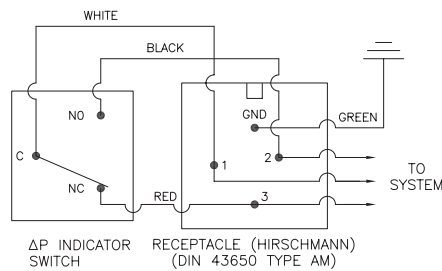
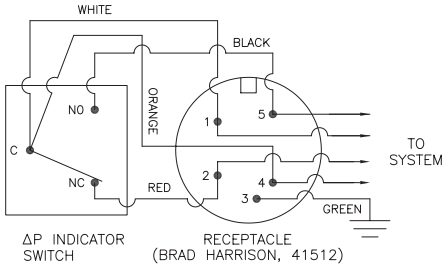

Note: The female plug (connector) is to be furnished by customer.

Plastic Electrical Housings

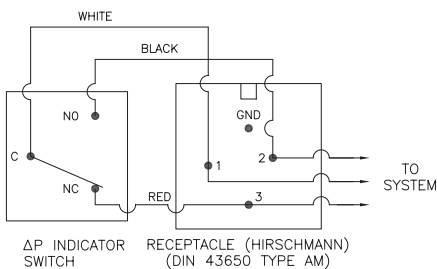
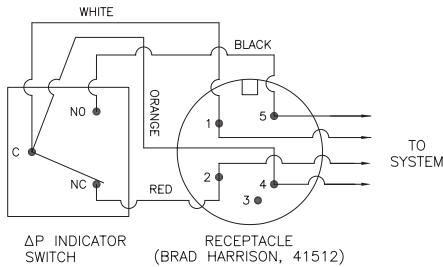

Note: The female plug (connector) is to be furnished by customer.

Differential Indicators: Indicators are designed to actuate at approximately 80% of bypass valve cracking pressure. It is recommended that an indicator with a bypass setting of 100 psid is used with a non-bypass housing.

Surge Control: This optional feature is used to dampen pressure surges or spikes to avoid premature actuation of the indicator. Surge control delays the indicator response.

Thermal Lockout: The Thermal Lockout prevents premature signaling of a bypass condition created by viscous fluid during cold start-ups. Normal indicator actuation capability is resumed once the operating temperature of the fluid reaches approximately 80°F / 27°C.

Applications

- High Pressure Circuits
- In-Plant Systems

Assembly - Side Views

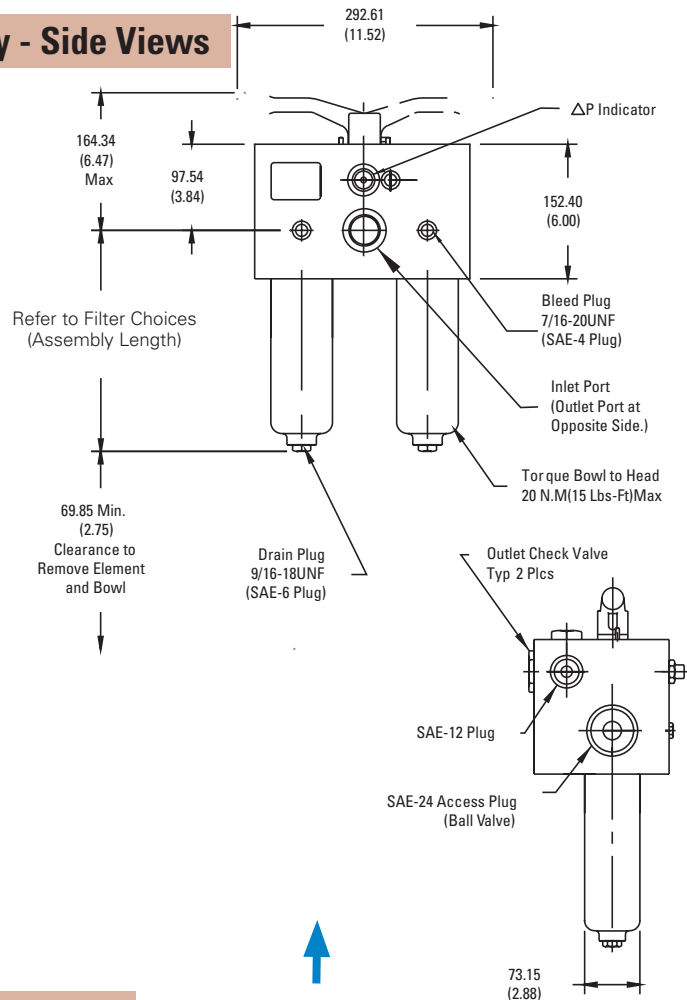

Head - Top View

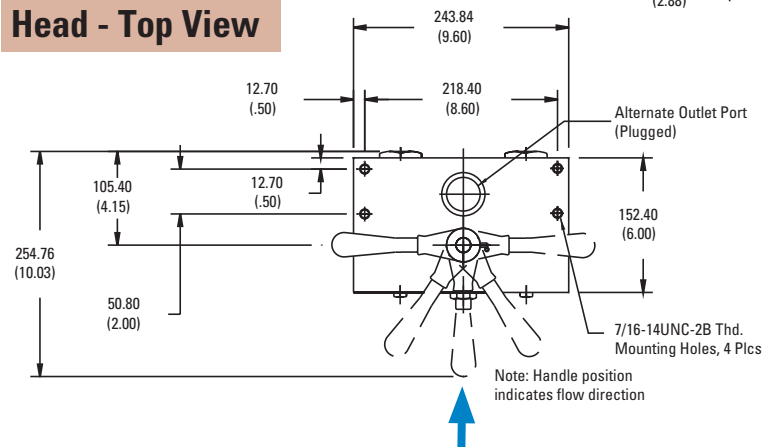



W322

Max Flow: 50 gpm (190 lpm)



W322 Components High-Performance DT Filter Choices

Media Type	$\beta_{x(c)} = 1000$ Rating based on ISO 16889	Length		Donaldson Part No.	Comments
		in	mm		
DT Synteq Synthetic	<4 μm	4.41	111.9	P566391	DT-9800-4-2UM
	5 μm	4.41	111.9	P566392	DT-9800-4-5UM
	8 μm	4.41	111.9	P566393	DT-9800-4-8UM
	12 μm	4.41	111.9	P566394	DT-9800-4-14UM
	23 μm	4.41	111.9	P566395	DT-9800-4-25UM
	<4 μm	8.28	210.3	P566396	DT-9800-8-2UM
	5 μm	8.28	210.3	P566397	DT-9800-8-5UM
	8 μm	8.28	210.3	P566398	DT-9800-8-8UM
	12 μm	8.28	210.3	P566399	DT-9800-8-14UM
	5 μm	4.46	113.2	P566406	DT-9801-4-5UM, High collapse
	12 μm	4.46	113.2	P566407	DT-9801-4-14UM, High collapse
	5 μm	8.16	207.2	P566408	DT-9801-8-5UM, High collapse
	12 μm	8.16	207.2	P566409	DT-9801-8-14UM, High collapse

Filter Notes

- All Donaldson DT filters utilize glass fiber media with an epoxy-based resin system for the ultimate in chemical compatibility.
- All Donaldson DT filters are potted with epoxy-based adhesives.
- Standard collapse DT designs are double wire-backed using epoxy-coated steel mesh for maximum pleat support and dirt capacity.
- High collapse designs are double wire-backed using stainless steel mesh.
- High collapse designs are also potted into machined aluminum endcaps for greater filter integrity in critical applications.
- Viton® seals are standard on all Donaldson DT filters. Viton® is a registered trademark of E. I. DuPont de Nemours and Company.

Performance Data

W322 Housing Only

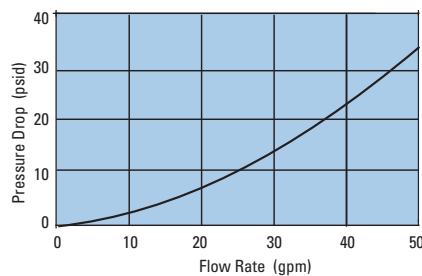

W322 4" DT Filter Only
DT-9800-4, 4"/102mm

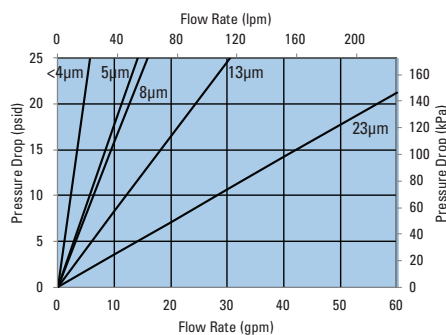

W322 4" DT Filter Only
DT-9801-4, 4"/102mm

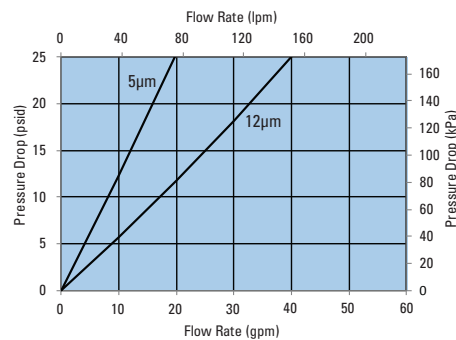

W322 8" DT Filter Only
DT-9800-8, 8"/203mm

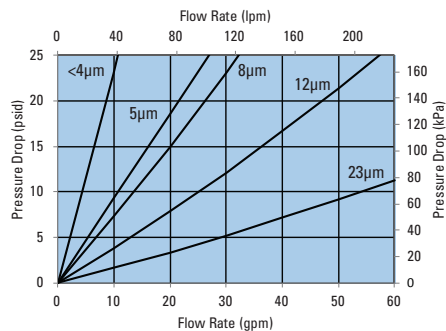

W322 8" DT Filter Only
DT-9801-8, 8"/203mm

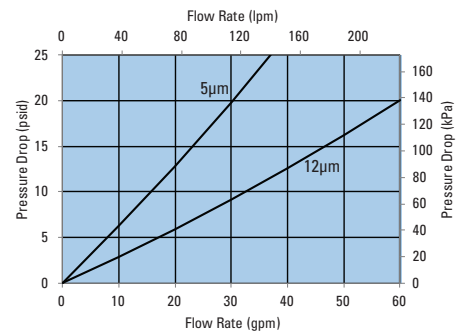



Housing Ordering Guide

Filter Assembly	W322 TABLE 1	1 TABLE 2	B TABLE 3	4 TABLE 4	D N TABLE 5	B TABLE 6	2 TABLE 7
-----------------	-----------------	--------------	--------------	--------------	------------------	--------------	--------------

Service Filter
Filters ordered separately. See previous page for filter options.

LEAD TIME NOTE:

This product is configured with the specifications and features of your choice. Please contact your Donaldson sales representative for lead time details.

Table 1

Filter Assembly	
CODE	DESCRIPTION
W322	Assembly

Table 2

Filter Collapse Options	
CODE	DESCRIPTION
1	150 psid for housing w/bypass valve
4	3000 psid for housing without bypass valve

Table 3

Port Size Options	
CODE	PORT SIZE
B	SAE-16 O-ring

Table 4

Bypass Setting Options	
CODE	BYPASS SETTING
1	Non-bypass
4	50 psid
6	90 psid

*Note: Use option 1 code only with 3000 psid collapse filter.

Table 5 (Primary)

Indicator Style and Setting	
CODE	ΔP INDICATOR STYLE & SETTING
A	Visual indicator 70 psid w/TL and surge
B	Electrical/visual 70 psid w/TL and surge
D	Electrical/visual 35 psid
E	Electrical/visual 100 psid
G	Electrical/visual 35 psid w/TL
I	Visual indicator 70 psid
J	ΔP indicator plug
L	Visual indicator 35 psid
M	Visual indicator 35 psid w/TL and surge
N	Electrical/visual 35 psid w/12" 3-wire flying lead
O	Visual indicator 100 psid
P	Visual indicator 100 psid w/TL and surge
R	Electrical switch 35 psid
S	Electrical/visual 100 psid w/12" 3-wire flying lead
T	Electrical switch 100 psid
U	Electrical switch 70 psid
V	Electrical/visual 70 psid w/TL
W	Electrical/visual 100 psid w/TL
Y	Electrical/visual 35 psid w/TL and surge
Z	Electrical/visual 100 psid w/TL and surge

TL (thermal lockout)

Table 5 (Secondary)

Receptacle Options	
CODE	ELECTRICAL STYLE
B	Brad Harrison® (5-pin)
H	Hirschmann® (4-pin)
N	None, for visual ΔP indicator

Table 6

Seal Options	
CODE	MATERIAL
B	Buna-N®
V	Viton®

Table 7

Assembly & Filter Length	
CODE (LGTH)	FILTER LENGTH
1 (6.88")	4.4"
2 (9.86")	8.2"

METRIC PORTING AVAILABLE

Change W322 to G322
Porting code B becomes 1"
ISO 228 BSPP

Media Ratings

Western Filter elements have been replaced by Donaldson DT high-performance cartridges.

WESTERN MEDIA CODE	DONALDSON DT MEDIA
01	<4μm DT Synteq Synthetic
03	5μm DT Synteq Synthetic
05	8μm DT Synteq Synthetic
10	12μm DT Synteq Synthetic
20	23μm DT Synteq Synthetic

For a complete filter interchange, visit crossreference.donaldson.com.

Brad Harrison® is a registered trademark of Woodhead Industries, Inc.
Hirschmann® is a registered trademark of Richard Hirschmann of America Inc.
Buna-N® and Viton® are registered trademarks of E. I. DuPont de Nemours and Co.